

# GARAGE ZILLA

GARAGE INTERIOR SPECIALISTS

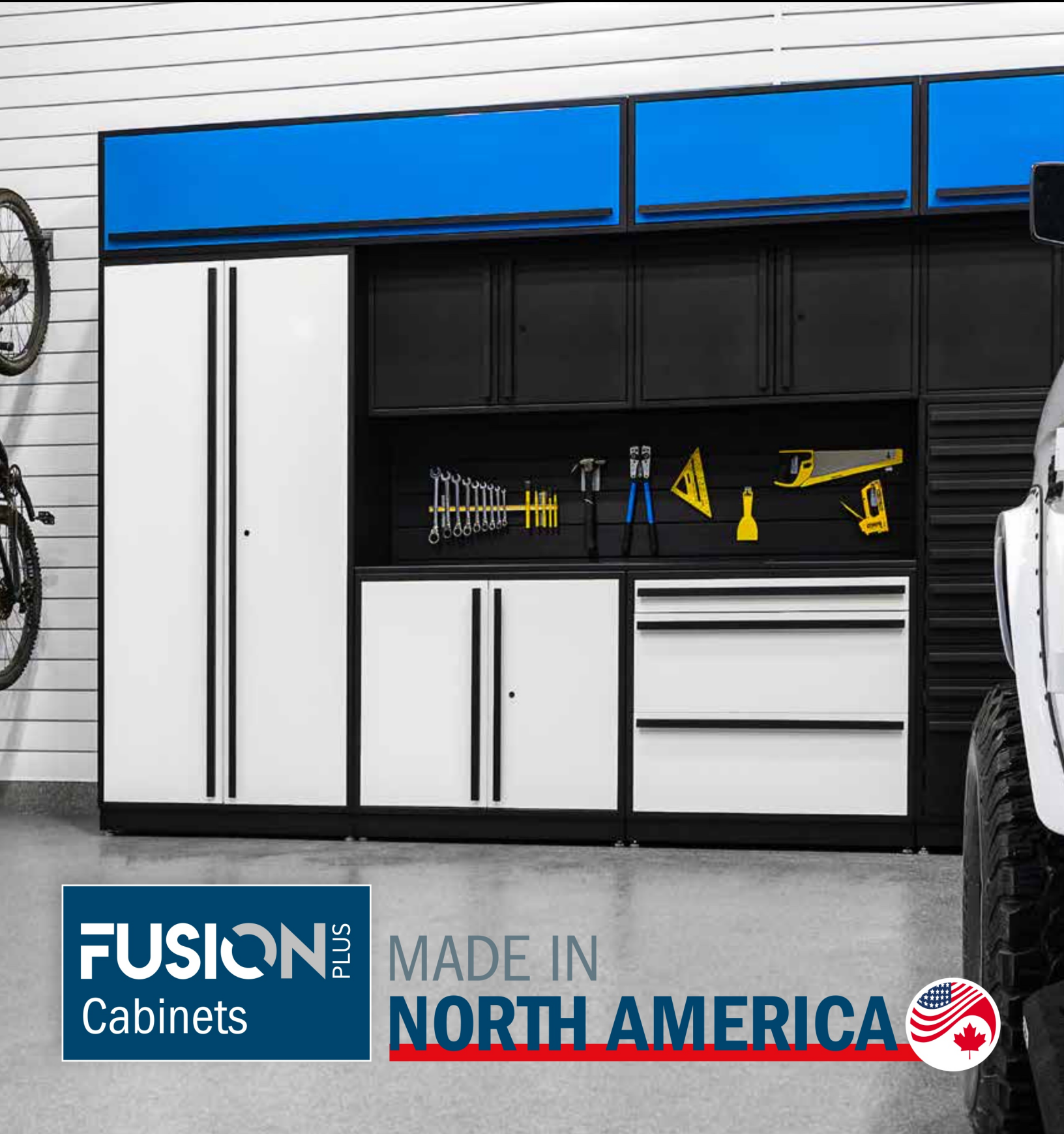

**FUSION** PLUS  
Cabinets

MADE IN  
**NORTH AMERICA**







# YOUR GARAGE IS AN INVESTMENT, DESIGN

## WHAT'S BEST FOR YOU!

Stop scrolling and start designing. It can be difficult to imagine what your garage could look like when browsing product options online. Our design center puts you in control of what you want, where you want it, and the color you want it in. Don't settle, choose.





# WHY CHOOSE OUR CABINETS ?

## 1 Fit

**Our brand-new state-of-the-art production facility employs the newest manufacturing technology and was engineered from the ground up to make only the best cabinets.**

- ▮ Accurate sheet metal shaping with state-of-the-art metal processing machines guarantees consistently manufactured cabinets every time.
- ▮ Precise robotic welds will ensure our cabinets are perfectly square.
- ▮ Simple yet elegant designs will make your neighbors jealous for years to come.

## 2 Finish

**It's essential to have quality products when investing in your home, which all starts with quality materials.**

- ▮ North American sourced steel guarantees the quality and durability of our cabinets.
- ▮ Zirconium Fluoride steel treatment seals out rust for years of protection.
- ▮ Advanced powder coating system and Canadian paint ensures optimal coverage.

## 3 Freedom

**Your home is unique to you and your personality, so why choose from cookie-cutter options for the biggest room in your home?**

- ▮ Huge capacity cabinets with 20 in. and 40 in. widths – bigger is better!
- ▮ Build your garage storage system to fit your needs with dozens of cabinet models and accessories to choose from.
- ▮ Customize your cabinets to your taste with our standard and premium color options.



# DESIGN YOUR UNIQUE SET FROM A VARIETY OF CABINET MODULES AND COLOR CHOICES!

## Standard

Standard colors are in stock and usually ship within 72 hours.

### Door colors



Black      Red      Traffic Gray

### Handle colors



Black      Silver

## Premium

Upgrade your cabinets with a premium hand-painted color. Premium colors carry a paint charge of \$395.00

### Door Colors



Pure white      Zinc yellow      Bright red orange      Pure green      Sky blue      Signal blue      Window gray

### Handle Colors



Pure white      Zinc yellow      Bright red orange      Red      Pure green      Sky blue      Signal blue      Window gray      Traffic Gray

## Bigger IS better

Proslat's 40 in. cabinets are industry leading and give you the most bang for your buck! Our competition may sell you on piece count, but Proslat wins in overall size, quality, and price per cubic foot.

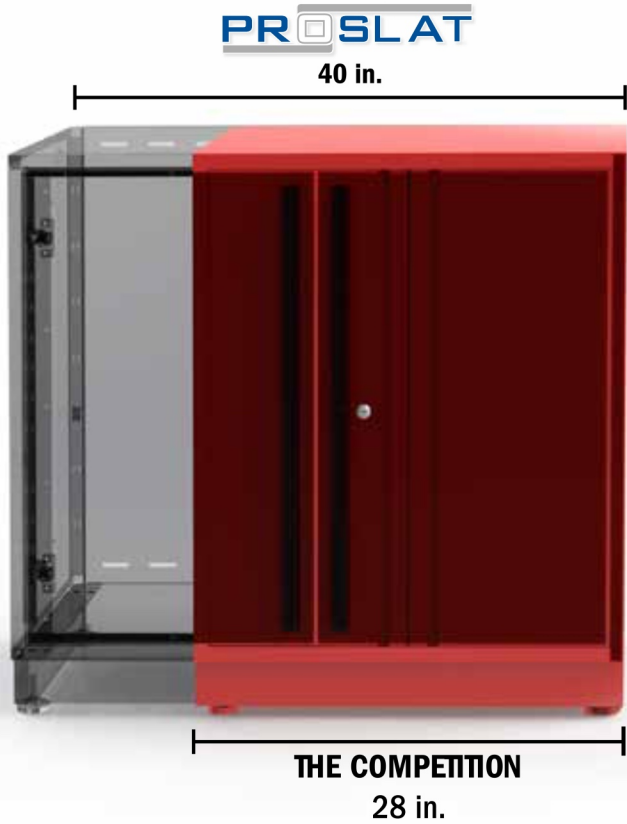

Made in North America	✓
18 gauge steel	✓
Fully welded construction	✓
Fulterer™ ball bearing slides	✓
Superior powder coated finish	✓
Lifetime warranty	✓
Easy to install and clean	✓
Over 10 color choices	✓
<b>THE BEST CHOICE</b>	✓

## ANATOMY



Patent pending Quad Corner construction

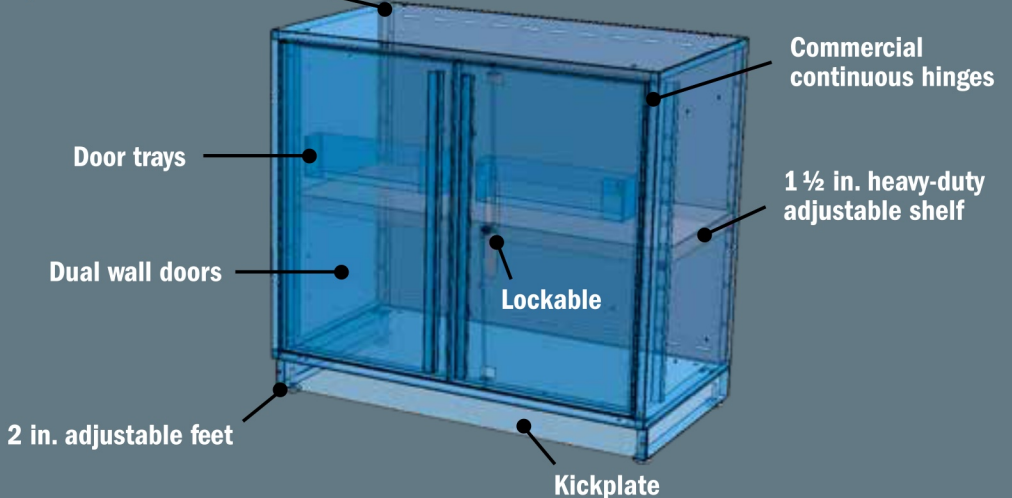

# SINK

This sink module can be used as a stand alone unit or integrated within your cabinet set. It is made of 16 gauge 304 stainless steel and comes with a commercial strainer. The Sink Base cabinet is practical and durable, made of 18 gauge steel, dual wall doors and comes in a powder coat paint finish. A choice of stainless steel or powder coated countertops are included with the sink.

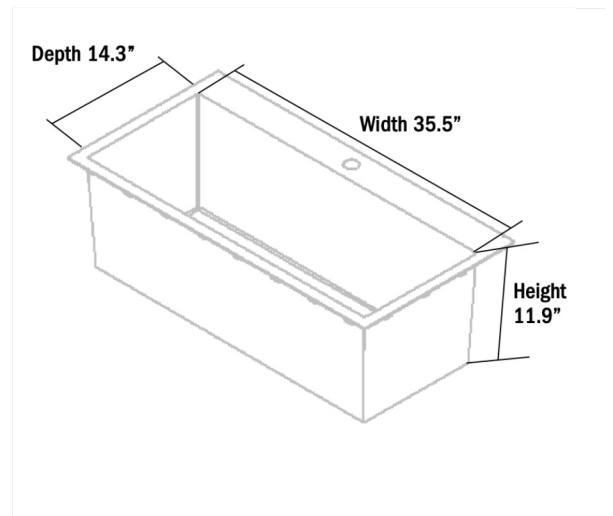

## Packed with features

Not only are the Fusion PLUS cabinets appealing they're also jam-packed with quality features such as *Fulterer* ball-bearing drawer slides, corrosion-resistant powder coat finish, dual wall doors, fully locking units, adjustable feet, and a durable work surface. What's new with Fusion PLUS? A larger variety of cabinets and the option to paint your doors and drawers.



## RUGGED CONSTRUCTION

Fusion PLUS cabinets are manufactured from solid 18 gauge steel with a zirconium treatment and finished with a superior powder coat. Fusion PLUS cabinets come fully welded which will dramatically reduce your installation time so you can enjoy your new investment in no time.







## Lifetime warranty

Fusion PLUS cabinets are backed by the best warranty in the industry.

All drawer slides and hinges come with a lifetime warranty.



## REFRIGERATION



**Did you know fridges and freezers are one of the most popular items found in a garage after tools?**

At Proslat, we take this to the next level! This matching set of all fridge or all freezer can be integrated into your cabinet set individually or together.

The appliances are finished in a textured slate black and are ENERGY STAR® rated. For full specifications, visit our design center.



## BEVERAGE CENTER

Whether you find yourself entertaining guests or needing more convenient refrigeration for your family, this beverage center with a stainless steel door frame delivers style and practicality.

Cool up to 117 cans under blue LED lights and on three adjustable wire shelves that accommodate different-sized beverages.



## Pantry

**We know pantry sounds funny in the garage but this item was designed to align your fridge with your 40 inch cabinets.**

It comes with 2 adjustable shelves and can hold anything from a can of soup to a bag of screws. Made of durable 18 gauge steel, dual wall door and finished with a powder coated paint.

## 40" cabinets



	3 Drawer base	5 Drawer base	10 Drawer base
Metal gauge	18	18	18
Cabinet size (WxHxD)	40 x 36.5 x 22 in.	40 x 36.5 x 22 in.	40 x 58.5 x 22 in.
Drawer quantity	3 drawers	5 drawers	10 drawers
Weight capacity	200 lb - 300 lb	200 lb - 300 lb	200 lb - 300 lb
Shelf quantity	–	–	–
Interior small drawer size (WxHxD)	37 x 4 x 20 in. (1x)	37 x 4 x 20 in. (4x)	37 x 4 x 20 in. (9x)
Interior large drawer size (WxHxD)	37 x 12½ x 20 in. (2x)	37 x 12½ x 20 in. (1x)	37 x 12½ x 20 in. (1x)

## 20" cabinets



Door is reversible



Door is reversible



Door is reversible

	1 door base	Locker	Wall mount
Metal gauge	18	18	20
Cabinet size (WxHxD)	20 x 36.5 x 22 in.	20 x 81.5 x 22 in.	20 x 23 x 15 in.
Weight capacity	200 lb per shelf	200 lb per shelf	200 lb per shelf
Shelf quantity	1 shelf	3 shelves	1 shelf



2 Door base	Sink base	Tall cabinet	Wall mount
18	18	18	20
40 x 36.5 x 22 in.	40 x 36.5 x 22 in.	40 x 81.5 x 22 in.	40 x 23 x 15 in.
–	–	–	–
200 lb per shelf	–	200 lb per shelf	200 lb per shelf
1 shelf	–	3 shelves	1 shelf
–	–	–	–
–	–	–	–

# OVERHEAD cabinets

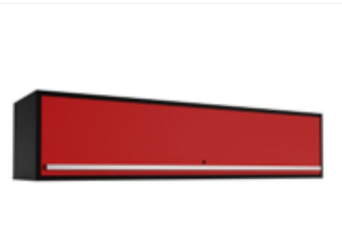

	40 inch	60 inch	80 inch
Metal gauge	20	20	20
Cabinet size (WxHxD)	40 x 18 x 22 in.	60 x 18 x 22 in.	80 x 18 x 22 in.
Weight capacity	200 lb	200 lb	200 lb
Shelf quantity	–	–	–

## SPECIALTY cabinets



Includes work surface



	Blind corner 62 inch	Corner Wall Mount	Pantry
Metal gauge	18	20	18
Size (WxHxD)	62 x 36.5 x 22 in.	22 x 23 x 22 in.	15 x 58.5 x 22 in.
Weight capacity	200 lb per shelf	200 lb per shelf	200 lb per shelf
Shelf quantity	1 shelf	1 shelf	2 shelves

## BACKSPLASHES

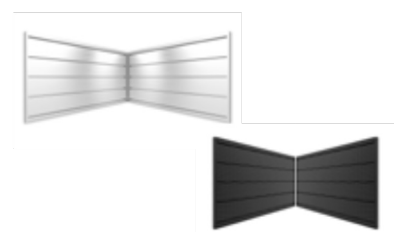

	Aluminum slatwall	Procore+ slatwall	Corner back splash
Color	Aluminum	Carbon fiber	Aluminum / Carbon fiber
Size (WxHxD)	40/60/80 x 21.5 x 0.5 in.	40/60/80 x 21.5 x 0.5 in.	22 x 21.5 x 0.5 in.
Weight capacity	150 lb/square foot	150 lb/square foot	150 lb/square foot

## WORK surfaces



	Stainless steel	Powder coated	Sink
Metal gauge	16	16	16
Size (WxHxD)	20/40/60/80 x 0.75 x 22 in.	20/40/60/80 x 0.75 x 22 in.	38 x 14.25 x 12 in.
Weight capacity	500 lb	500 lb	—
Color	Stainless	Black	Stainless

# REFRIGERATION



	11 cu ft Refrigerator	117 Can Beverage Center	8.5 cu ft Upright Freezer
Size (WxHxD)	23.9 x 59.1 x 24.8 in.	17.5 x 33.8 x 19.7 in.	23.9 x 59.1 x 24.8 in.
Capacity	11 cu. ft.	11 cu. ft. / 117 can	8.5 cu. ft.
Shelf quantity	5 shelves	3 shelves	3 shelves
Color	Slate black	Stainless steel frame	Slate black
Warranty	18 months	18 months	18 months

# POWER

## LIGHT them up

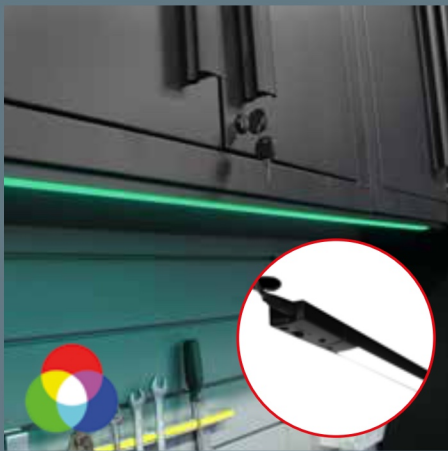

Our rugged light bars are 40 inches wide with the option of connecting two together for longer surfaces. Light color output options are cool white or RGB.

## CHARGING station



Everything these days is wireless, this is why we developed a charging shelf to organize your tools and chargers all in one spot.

## POWER BAR insert



Each wall mount comes with a punch-out which makes it simple for installation and instant connectivity. The power bar is equipped with 2 USB inserts and 3 sockets.

## ACCESSORIES

Personalize your cabinets, based on your needs. We have a variety of cabinet accessories to help make your garage the perfect extension to your home.

### Backsplash hook kit



The backsplash hook kit comes with the most practical accessories for your work station where your most popular tools are at arm's reach.

### Drawer organizers



Keep your drawers organized with this 11-piece kit. Configure compartments to suit the size of the items being stored.

### 2-pack Door trays



This 2-pack of door trays comes in handy for those ready to grab products all while giving you additional storage. Can be added to all modules with doors.

### Coat hanger



Thinking inside the box, utilize your cabinets for clothing storage. The coat hanger is ideal to keep soiled work clothes in the garage or even for winter coat storage in the warmer months. Available for the 40 in. tall cabinet only.

### Utility hook



The Utility hook is perfect for keeping bulky objects hidden away. Get extra storage for items such as rakes, brooms, hockey and golf bags. Available for the 40 in. tall cabinet only.

### Counter saver



Protect your countertops with our 40 inch neoprene work mat.

### Extra shelves



Need more storage? Extra shelves are available for both the 20 in. locker and 40 inch tall cabinet.



# Barrett-Jackson® EDITION



**Designed in conjunction with the team at Barrett-Jackson® and manufactured by Proslat, Barrett-Jackson® Edition cabinets are as coveted as the cars passing through the auction.**

Built with 18 gauge steel, dual wall doors, ball bearing drawer slides and backed by a lifetime guarantee. These cabinets will be the cornerstone of your garage for years to come.





## GARAGE ORGANIZATION

